

Carlon[®]
LAMSON & SESSIONS

NEW!

Adjustable Floor Box Kit with White Cover

THE FAST, EASY WAY TO PUT A PLUG ANYWHERE YOU NEED IT!

- Eliminates extension cords
- **Great for home offices & entertainment rooms**
- Easy to use – kit includes everything you need!



ADJUSTS TO MOST FINISHED FLOOR HEIGHTS!

Kit includes:

- Nonmetallic White Cover
- Adjustable 20 cu. in. Nonmetallic Floor Box
- Duplex Receptacle
- Molded Cable Clamps
- Mounting Bracket
- All mounting hardware



2-HR-F
FLOOR BOX
696Y

Assembled in USA
Patent #5,289,934

B121BFBRW

INSTALLATION INSTRUCTIONS



Install clip over subfloor.

This floor box is designed to be mounted on a joist or subfloor. It can be installed on the top of the joist or from the bottom if the thickness of the joist is sufficient to allow installation of the box. If the unit is to be installed from the bottom of the joist, check prior to installation to ensure there is sufficient adjustment remaining as this type of installation is non-standard.

The unit can also be installed using the old work (small) bracket that is included. This bracket facilitates the installation of the box in areas where the larger new work bracket cannot be used. The old work bracket edge is hidden by the cover when installed. However, before cutting into the wood, you must ensure that the mounting screws will properly support the bracket/box installation.

For planning purposes please ensure that the maximum installed height to the bottom of the cover does not exceed 1-3/4" above the top of the mounting bracket.

The kit is listed as a floor box by Underwriters Laboratories. The kit also has a two (2) hour fire classification. Only covers manufactured for this box can be used with this assembly.

Floor box kit should be installed by a certified electrician.



Screw in to adjust to height of flooring or carpet.



Beautiful flush fit every time!



Assembled in USA
Patent #5,289,934

Installation – New Work Bracket

1. The new work metal bracket may be installed on the floor joist below a 3/4 inch subfloor. When a thicker subfloor is used we recommend cutting a hole in the subfloor using the box as a template and adjacent to the joist so the mounting screws will engage the joist as well as the subfloor. Use the four (4) #6 1-3/4" self-tapping screws supplied with the kit to mount the bracket.
2. If the new work bracket is installed from the underside of the joist, ensure the alignment with the box and opening before installing the bracket. Use the four (4) #6 1-1/4" self-tapping screws supplied with the kit to mount the bracket.
3. The romex wire can then be pulled through the desired clamp and the box aligned in the bracket slide. Ensure the adjusting screw is aligned on the bracket and rotate the screw clockwise using an electric or pneumatic POWER screw gun. (The adjusting screw can be turned manually with a screwdriver, but this is a self-tapping screw that is cutting threads into hardened steel and it will be very, very difficult.)
4. Adjust the box flush to 1/2" above floor, leaving sufficient room to complete the installation.
5. Wire the receptacle in accordance with the National Electrical Code.
6. Cut the top of the tube containing the Dow Corning #4 sealant and apply an 1/8 inch bead of the sealant around the outside rib of the cover that mates with the box. Align the receptacle on the recessed bosses and place the cover on the box with outlet caps open. Push cover into the box until rib on bottom of cover engages with box.
7. Insert the two (2) 6-32x1 inch flat-head machine screws in the holes in the cover, ensuring that the screw is aligned with and captivates the receptacle. **DO NOT OVER TORQUE.** Tighten the screws to a maximum of 6 to 8 inch pounds. Ensure bottom of cover is still engaged with box.
8. Remove the plug on the cover that hides the adjusting screw opening and set it aside where it will not be misplaced.
9. Using the adjusting screw, adjust the assembly so cover flange is flush with floor covering. Do not pre-load the cover against the floor covering. Place the "button" you previously set aside in a safe place over the adjusting screw opening.
10. In order to ensure a watertight seal, apply a thin layer of the Dow Corning #4 sealant around the cap and cover mating surfaces.
11. Turn the coin slot lock in the center of the cover in either direction to lock the outlet caps.

Installation – Old Work Bracket

1. As indicated in the prior instructions, ensure there is sufficient depth of the floor covering to install the old work bracket. If not, the bracket must be installed adjacent to a joist where the screws will engage the joist/flooring for support.
2. Use the box as a template and cut out an opening in the floor cover.
3. Place the bracket on the side of the opening where it is to be mounted with the two tabs up and resting on the surface. (Be careful not to drop the bracket into the opening.)
4. Install the bracket using the two (2) square drive trim head screws provided in the kit. Since the screws are installed at an angle, there may be a small part of the screw head that protrudes. This is to be anticipated and will not interfere with the installation of the box.
5. Use the installation instructions for the new work bracket from this point forward starting with step 3.



Old work bracket installation for tight locations or cut-in situations

MAINTENANCE

To ensure continued service, it is recommended that the sealing surfaces of the caps and cover be kept free of debris.

Carlon®

LAMSON & SESSIONS

25701 Science Park Drive • Cleveland, Ohio 44122 • www.carlon.com

Adjustable Floor Box Assembly

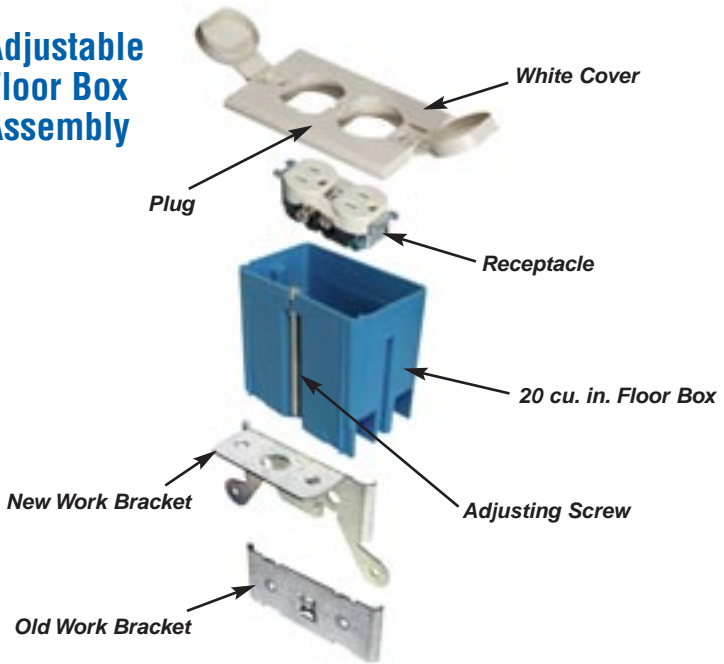

Package Contents

- One (1) New Work Bracket
- One (1) Old Work Bracket
- One (1) 20 cubic in. UL Listed floor box
- One (1) UL Listed white floor cover
- One (1) short shank receptacle
- Two (2) 6-32x1 flat head machine screws
- Four (4) #6 1-1/4 self-tapping flat head screws
- Two (2) #6 square drive trim head screws
- One (1) tube Dow Corning #4 sealant
- Installation instructions

Caution: The floor box has undergone a scrub water test as required by UL under criteria specified in 514C for this type of application. However, it is not intended for nor approved for wet locations or outdoor installation.