

This information provided by:

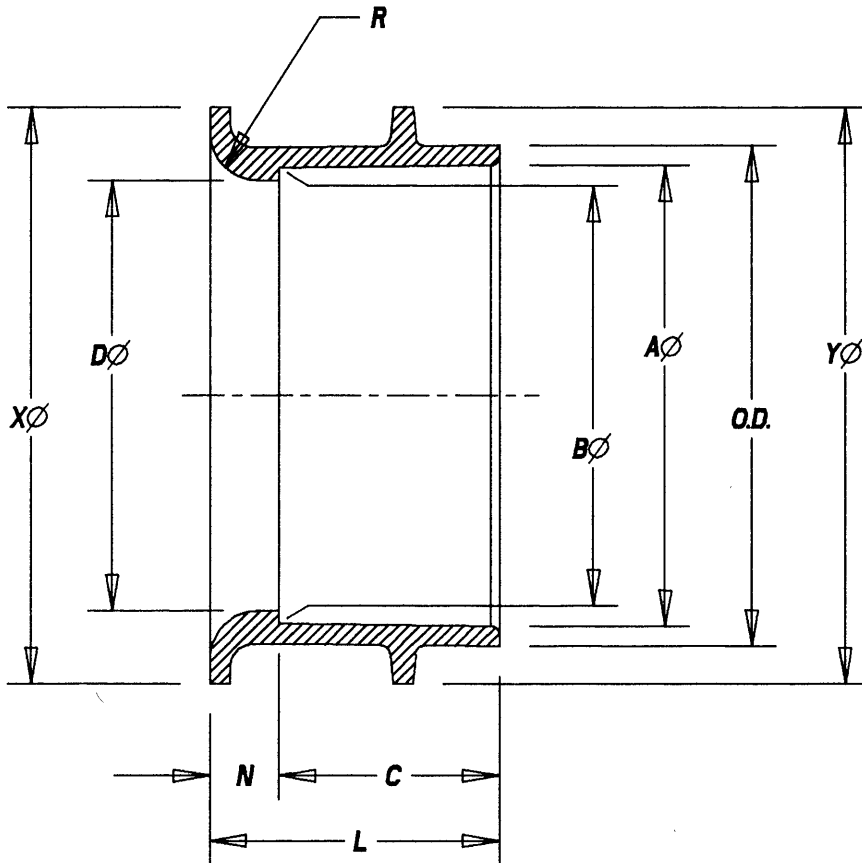

Gross Automation
www.grossautomation.com

Call Toll Free:
800-349-5827



NOTE:
ALL DIMENSIONS ARE IN INCHES AND MILLIMETERS.

PART NO.	SIZE	A	B	D	O.D.	X	Y	C	N	L	R
E997F	1"	1.325 [33.7]	1.312 [33.3]	1.225 [31.1]	1.525 [38.7]	1.756 [44.6]	1.788 [45.4]	1.515 [38.5]	.375 [9.5]	1.890 [48.0]	.312 [7.9]
E997G	1-1/4"	1.673 [42.5]	1.662 [42.2]	1.540 [39.1]	1.882 [47.8]	2.01 [51.1]	2.145 [54.5]	1.515 [38.5]	.375 [9.5]	1.890 [48.0]	.312 [7.9]
E997H	1-1/2"	1.910 [48.5]	1.900 [48.3]	1.765 [44.8]	2.125 [54.0]	2.255 [57.3]	2.385 [60.6]	1.519 [38.6]	.375 [9.5]	1.894 [48.1]	.312 [7.9]
E997J	2"	2.393 [60.8]	2.369 [60.2]	2.193 [55.7]	2.663 [67.6]	2.990 [75.9]	2.958 [75.1]	1.135 [28.8]	.357 [9.1]	1.492 [37.9]	.20 [5.1]
E997K	2-1/2"	2.890 [73.4]	2.868 [72.8]	2.460 [62.5]	3.062 [77.8]	3.480 [88.4]	3.488 [88.6]	1.48 [37.6]	.520 [13.2]	2.00 [50.8]	.25 [6.4]
E997L	3"	3.515 [89.3]	3.492 [88.7]	3.069 [77.9]	3.688 [93.7]	4.09 [103.9]	4.09 [103.9]	1.610 [40.9]	.390 [9.9]	2.00 [50.8]	.25 [6.4]
E997M	3-1/2"	4.018 [102.1]	3.993 [101.4]	3.540 [89.7]	4.226 [107.3]	4.598 [116.8]	4.598 [116.8]	1.695 [43.1]	.440 [11.2]	2.135 [54.2]	.25 [6.4]
E997N	4"	4.515 [114.7]	4.482 [113.8]	4.020 [102.1]	4.995 [126.9]	5.310 [134.9]	5.230 [132.8]	1.780 [45.2]	.479 [12.2]	2.259 [57.4]	.38 [9.6]
E997P	5"	5.588 [141.9]	5.545 [140.8]	5.050 [128.3]	5.960 [151.4]	6.360 [161.5]	6.360 [161.5]	1.97 [50.0]	.510 [13.0]	2.480 [63.0]	.38 [9.6]
E997R	6"	6.653 [169.0]	6.590 [167.4]	6.070 [154.2]	6.930 [176.0]	7.370 [187.2]	7.370 [187.2]	2.17 [55.1]	.560 [14.2]	2.730 [69.3]	.38 [9.6]

TITLE		BELL ENDS		DRN	DATE	PART NO:	
LAMSON & SESSIONS		ALL DRAWINGS ARE THE PROPERTY OF LAMSON & SESSIONS AND SHALL NOT BE REPRODUCED IN ANY FORM WITHOUT LAMSON & SESSIONS' APPROVAL AND ARE TO BE PROMPTLY RETURNED UPON REQUEST.		DPR	6-26-97	E997 SERIES	
Gross Automation (877) 268-3700 · www.carlionsales.com · sales@grossautomation.com				APP.	DATE	DRAWING NO:	
						AC03133	
						REV. A	